

Product Specification



Model: GDT-3.5M320480NB-02

Rev. No.

Issued Date.

Page.

A

2016,04,27

1 / 19

Thin-Film-Transistor LCD Module

Model: GDT-3.5M320480NB-02

Acceptance

Approved and Checked by

Approved by

Checked by

Made by

XIAMEN OCULAR OPTICS CO., LTD

Product Specification



Model: GDT-3.5M320480NB-02

Rev. No.

Issued Date.

Page.

A

2016,04,27

3 / 19

1. General Description and Features

GDT-3.5M320480NB-02 is a TM (Transmissive) type color active matrix TFT (Thin Film Transistor) liquid crystal display (LCD) that uses amorphous silicon TFT as a switching device. This model is composed of a TFT-LCD module, a driver circuit and a back-light unit . The resolution of a 3.5" contains 320RGBx480 dots and can display up to 262K colors. The following table described the features of GDT-3.5M320480NB-02

LCD Module

Item	Specification	Unit
Screen Size	3.5inches	Diagona
Display Resolution	320RGB(H)x480(V)	Dot
Active Area	48.96 (H) x 73.44 (V)	mm
Outline Dimension	56.54(W) x 84.96(H) x 2.25 (D)	mm
Display Mode	Normally white/Transmissive	--
Pixel Arrangement	RGB-Vertical Stripe	--
Display Color	262K	--
Gray scale inversion Direction	12o'clock	
Viewing Direction	6 o'clock	--
Drive IC	ILI9488	--
Surface luminance	400 cd/m ²	

Product Specification

	Model: GDT-3.5M320480NB-02	Rev. No.	Issued Date.	Page.
		A	2016,04,27	4 / 19

2. Mechanical Information

Item		Min.	Typ.	Max.	Unit	Note
Module Size	Horizontal (H)	--	56.54	--	mm	--
	Vertical (V)	--	84.96	--	mm	(1)
	Thickness (T)	--	2.25	--	mm	(2)
Weight		--	N/A	--	g	--

Note (1) Not include FPC.

Refer to the Outline Dimension for further information.

(2) Back-light unit are included.

3. Electrical Specifications

3.1 Absolute Max. Ratings

3.1.1 Absolute Ratings of Environment

If the operating condition exceeds the following absolute maximum ratings, the TFT LCD module may be damaged permanently.

(Ta=25±2°C, V_{SS}=GND=0)

Item	Symbol	Min.	Max.	Unit	Note
Storage temperature	T _{STG}	-30	80	°C	(1)
Operating temperature	T _{OPR}	-20	70	°C	(1,2,3)

Note (1) 95 % RH Max. (40 °C ≥ Ta). Maximum wet-bulb temperature at 39 °C or less. (Ta > 40 °C)
No condensation.

Note (2) In case of below 0°, the response time of liquid crystal (LC) becomes slower and the color of panel becomes darker than normal one. Level of retardation depends on temperature, because of LC's character

Note (3) Only operation is guaranteed at operating temperature. Contrast, response time, another display quality are evaluated at +25°C.

Product Specification



Model: GDT-3.5M320480NB-02

Rev. No.

Issued Date.

Page.

A

2016,04,27

5 / 19

3.2 Electrical Absolute Rating

3.2.1 TFT-LCD Module

(Voltage Referenced to VSS)

Item	Symbol	Value		Unit	Condition
		Min.	Max.		
Digital Power Supply Voltage	VDD	VSS-0.3	5.0	V	--

3.2.2 Back-Light Unit

($T_a=25\pm 2^\circ\text{C}$)

Item	Symbol	Min.	Max.	Unit	Note
current	I_f	--	30	mA	(1)
voltage	V_R	--	5.0	V	(1)

Note (1) Permanent damage to the device may occur if maximum values are exceeded or reverse voltage is loaded. Functional operation should be restricted to the conditions described under normal operating conditions.

Product Specification

 XIAMEN OCULAR	Model: GDT-3.5M320480NB-02	Rev. No.	Issued Date.	Page.
		A	2016,04,27	6 / 19

4 Electrical Characteristics

4.1 Backlight Unit

The back-light system is an edge-lighting type with six white LEDs (Light Emitting Diode).

($T_a=25\pm 2^\circ\text{C}$)

Item	Symbol	Value			Unit	Condition
		Min.	Typ.	Max.		
LED Voltage	V_F	2.8	3.2	3.4	V	
LED Current	I_F	-	120		mA	
Power Consumption	P_{BL}	-	-	-	mW	

Note (1) Where $I_F = 120\text{A}$, $V_F = 3.2\text{V}$ $P_{BL} = V_F \times I_F$

Product Specification



Model: GDT-3.5M320480NB-02

Rev. No.

Issued Date.

Page.

A

2016,04,27

7 / 19

5 Input Terminal Pin Assignment

PIN.N O	SYMBOL	I/O/P	FUNCTI	MEMARK																																				
1	LED A	P	POWER FOR BACKLIHT(ANODE)																																					
2	LED K1	P	POWER FOR BACKLIHT(CATHODE)																																					
3	LED K2	P	POWER FOR BACKLIHT(CATHODE)																																					
4	NC																																							
5	NC																																							
6	NC																																							
7	IMO		Select the interface mode																																					
8	LM1	I	<table border="1" style="margin-left: auto; margin-right: auto;"> <thead> <tr> <th>IM2</th> <th>IM1</th> <th>IMO</th> <th>Interface</th> </tr> </thead> <tbody> <tr> <td>0</td> <td>0</td> <td>0</td> <td>MIPI-DBI Type B 24-bit bus (DB_EN = 1)</td> </tr> <tr> <td>0</td> <td>0</td> <td>0</td> <td>MIPI-DBI Type B 18-bit bus (DB_EN = 0)</td> </tr> <tr> <td>0</td> <td>0</td> <td>1</td> <td>MIPI-DBI Type B 9-bit bus</td> </tr> <tr> <td>0</td> <td>1</td> <td>0</td> <td>MIPI-DBI Type B 16-bit bus</td> </tr> <tr> <td>0</td> <td>1</td> <td>1</td> <td>MIPI-DBI Type B 8-bit bus</td> </tr> <tr> <td>1</td> <td>0</td> <td>1</td> <td>MIPI-DBI Type C Option 1 (3-line SPI)</td> </tr> <tr> <td>1</td> <td>1</td> <td>0</td> <td>MIPI DSI</td> </tr> <tr> <td>1</td> <td>1</td> <td>1</td> <td>MIPI-DBI Type C Option 3 (4-line SPI)</td> </tr> </tbody> </table>	IM2	IM1	IMO	Interface	0	0	0	MIPI-DBI Type B 24-bit bus (DB_EN = 1)	0	0	0	MIPI-DBI Type B 18-bit bus (DB_EN = 0)	0	0	1	MIPI-DBI Type B 9-bit bus	0	1	0	MIPI-DBI Type B 16-bit bus	0	1	1	MIPI-DBI Type B 8-bit bus	1	0	1	MIPI-DBI Type C Option 1 (3-line SPI)	1	1	0	MIPI DSI	1	1	1	MIPI-DBI Type C Option 3 (4-line SPI)	
IM2	IM1	IMO		Interface																																				
0	0	0		MIPI-DBI Type B 24-bit bus (DB_EN = 1)																																				
0	0	0	MIPI-DBI Type B 18-bit bus (DB_EN = 0)																																					
0	0	1	MIPI-DBI Type B 9-bit bus																																					
0	1	0	MIPI-DBI Type B 16-bit bus																																					
0	1	1	MIPI-DBI Type B 8-bit bus																																					
1	0	1	MIPI-DBI Type C Option 1 (3-line SPI)																																					
1	1	0	MIPI DSI																																					
1	1	1	MIPI-DBI Type C Option 3 (4-line SPI)																																					
9	IM2																																							
10	RESET	I	Reset input signal Initialize the chip with a low input. Be sure to execute a power-on reset after supplying power.																																					
11	VSYNC	I	DPI: Frame synchronizing signal <i>Fix to DGND level when not in use.</i>																																					
12	HSYNC	I	DPI: Line synchronizing signal <i>Fix to DGND level when not in use.</i>																																					
13	DOTCLK	I	DPI: Dot clock signal <i>Fix to IOVCC level when not in use.</i>																																					
14	DE	I	DPI: A data ENABLE input signal <i>Fix to DGND level when not in use.</i>																																					

Product Specification

 XIAMEN OCULAR	Model: GDT-3.5M320480NB-02	Rev. No.	Issued Date.	Page.
		A	2016,04,27	8 / 19

15-32	DB17-DB0	I/O	<table border="1" style="width: 100%; border-collapse: collapse; margin-bottom: 5px;"> <thead> <tr> <th style="text-align: center;">Interface Mode</th> <th style="text-align: center;">Data Pin in Use</th> </tr> </thead> <tbody> <tr> <td>MIPI-DBI Type B 24-bit bus (DB_EN = 1)</td> <td>DB [23:0]</td> </tr> <tr> <td>MIPI-DBI Type B 18-bit bus (DB_EN = 0)</td> <td>DB [17:0]</td> </tr> <tr> <td>MIPI-DBI Type B 16-bit bus</td> <td>DB [15:0]</td> </tr> <tr> <td>MIPI-DBI Type B 9-bit bus</td> <td>DB [8:0]</td> </tr> <tr> <td>MIPI-DBI Type B 8-bit bus</td> <td>DB [7:0]</td> </tr> <tr> <td>MIPI-DPI 24-bit</td> <td>DB [23:0]</td> </tr> <tr> <td>MIPI-DPI 18-bit</td> <td>DB [17:0]</td> </tr> <tr> <td>MIPI-DPI 16-bit</td> <td>DB [15:0]</td> </tr> </tbody> </table> <p><i>Fix to DGND level when not in use.</i></p>	Interface Mode	Data Pin in Use	MIPI-DBI Type B 24-bit bus (DB_EN = 1)	DB [23:0]	MIPI-DBI Type B 18-bit bus (DB_EN = 0)	DB [17:0]	MIPI-DBI Type B 16-bit bus	DB [15:0]	MIPI-DBI Type B 9-bit bus	DB [8:0]	MIPI-DBI Type B 8-bit bus	DB [7:0]	MIPI-DPI 24-bit	DB [23:0]	MIPI-DPI 18-bit	DB [17:0]	MIPI-DPI 16-bit	DB [15:0]	
Interface Mode	Data Pin in Use																					
MIPI-DBI Type B 24-bit bus (DB_EN = 1)	DB [23:0]																					
MIPI-DBI Type B 18-bit bus (DB_EN = 0)	DB [17:0]																					
MIPI-DBI Type B 16-bit bus	DB [15:0]																					
MIPI-DBI Type B 9-bit bus	DB [8:0]																					
MIPI-DBI Type B 8-bit bus	DB [7:0]																					
MIPI-DPI 24-bit	DB [23:0]																					
MIPI-DPI 18-bit	DB [17:0]																					
MIPI-DPI 16-bit	DB [15:0]																					
33	SDO	O	DBI Type C SDO: Serial data output <i>Leave the pin open when not in use.</i>																			
34	SDI	I/O	DBI Type C DIN/SDA: serial data input/output bi-direction pin <i>Fix to IOVCC or DGND level when not in use.</i>																			
35	RD	I	DBI Type B: serve as a read signal <i>Fix to IOVCC or DGND level when not in use.</i>																			
36	WR(D/C)	I	DBI Type B: WRX pin, serves as a write signal DBI Type C: SCL pin as Serial Clock when operates in the serial interface <i>Fix to IOVCC or DGND level when not in use.</i>																			
37	(D/C)(SCL)	I	DBI Type B: Data/Command Selection pin Low: Command High: Parameter <i>Fix to IOVCC or DGND level when not in use.</i>																			
38	CS	I	DBI Type B: Chip select input signal Low: the chip is selected and accessible High: the chip is not selected and not accessible <i>Fix to IOVCC or DGND level when not in use.</i>																			
39	TE	O	Serve as a TE (Tearing Effect) output signal <i>Leave the pin open when not in use.</i>																			
40	VDDI	P	A supply voltage to the digital circuit. Connect to an external power supply of 1.65 ~ 3.3V.																			
41	VDDI	P																				
42	VCI	P	A supply voltage to the analog circuit. Connect to an external power supply of 2.5 ~ 3.3V. <i>Connect to a stabilizing capacitor between VCI and GND.</i>																			
43	GND	P	POWER GROUND																			
44	XR	I	The TP Signal																			
45	YD	I	The TP Signal																			

Product Specification

 XIAMEN OCULAR	Model: GDT-3.5M320480NB-02	Rev. No.	Issued Date.	Page.
		A	2016,04,27	9 / 19

46	XL	I	The TP Signal	
47	YU	I	The TP Signal	
48	GND	P	POWER GROUND	
49	GND	P	POWER GROUND	
50	GND	P	POWER GROUND	

6 LCD Optical Characteristics

Optical specification

Item	Symbol	Condition	Min.	Typ.	Max.	Unit	Note
Transmittance (without Polarizer)	T (%)	—	—	(14.74)	—	—	
Contrast Ratio	CR	$\theta=0$	400	500	—	—	(1)(2)
Response time	Rising	T_R	—	(4)	(8)	msec	(1)(3)
	Falling	T_F	—	(12)	(24)		
Color gamut	S(%)			(60)		%	
Color chromaticity (CIE1931)	White	W_x		(0.283)	(0.303)	(0.323)	(1)(4) CF glass
		W_y		(0.305)	(0.325)	(0.345)	
	Red	R_x		(0.606)	(0.626)	(0.646)	
		R_y		(0.314)	(0.334)	(0.354)	
	Green	G_x		(0.257)	(0.277)	(0.297)	
		G_y		(0.529)	(0.549)	(0.569)	
	Blue	B_x		(0.122)	(0.142)	(0.162)	
B_y			(0.102)	(0.122)	(0.142)		
Viewing angle	Hor.	θ_L	CR>10	60	70	—	Viewing Angle base on using EWV Polarizer , Reference Only
		θ_R		60	70	—	
	Ver.	θ_U		60	70	—	
		θ_D		40	60	—	
Optima View Direction	12 O'clock						(5)

Product Specification



Model: GDT-3.5M320480NB-02

Rev. No.

Issued Date.

Page.

A

2016,04,27

10 / 19

Measuring Equipment

FPM520 of Westar Display technologies, INC., which utilized SR-3 for Chromaticity and BM-5A for other optical characteristics.

Note (1) Definition of Viewing Angle :

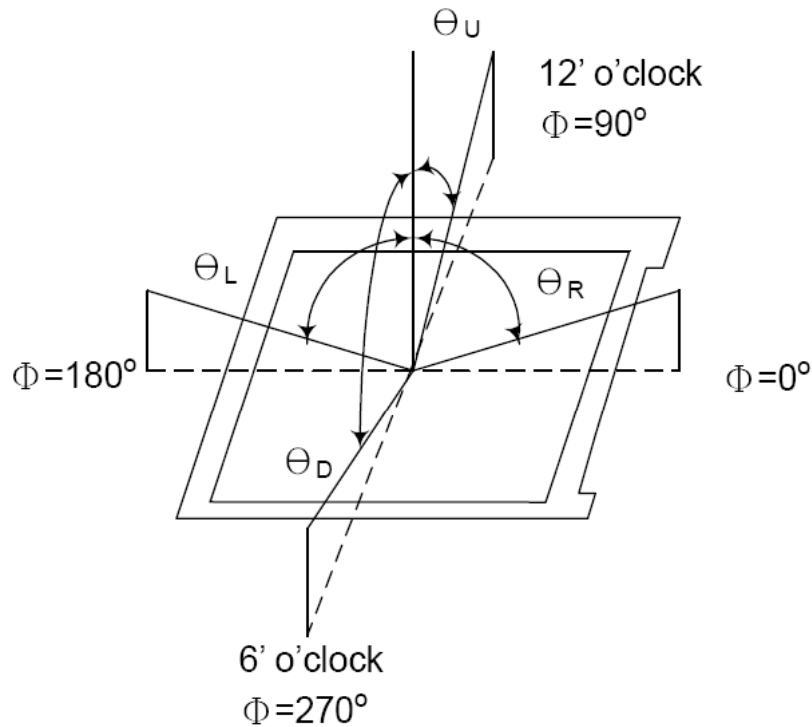

Note (2) Definition of Contrast Ratio(CR) :
measured at the center point of panel

$$CR = \frac{\text{Luminance with all pixels white}}{\text{Luminance with all pixels black}}$$

Product Specification

 XIAMEN OCULAR	Model: GDT-3.5M320480NB-02	Rev. No.	Issued Date.	Page.
		A	2016,04,27	11 / 19

Note (3) Definition of Response Time : Sum of T_R and T_F

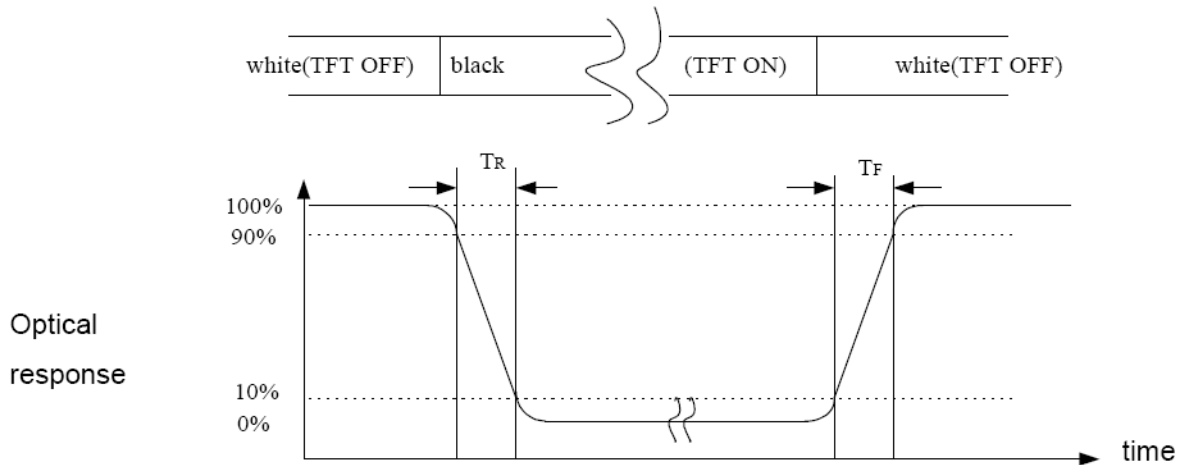

Note (4) Definition of optical measurement setup

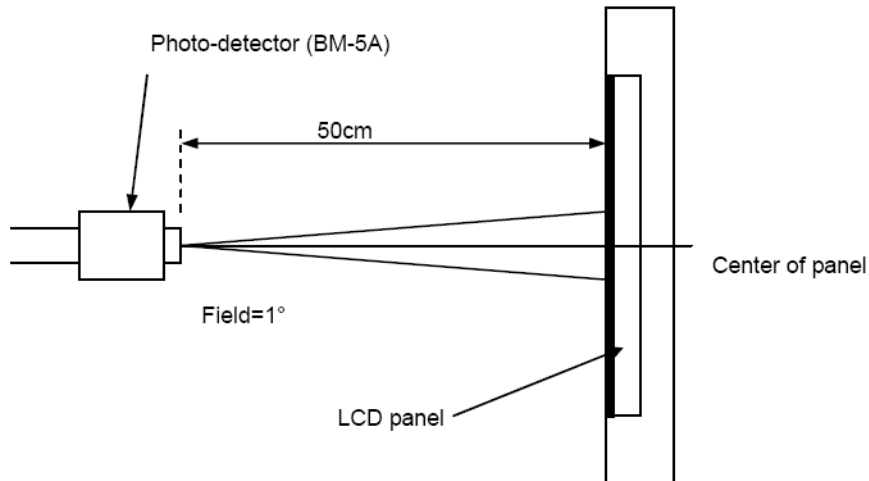

Product Specification



Model: GDT-3.5M320480NB-02

Rev. No.

Issued Date.

Page.

A

2016,04,27

12 / 19

7 Interface Timing

DPI (Display Parallel 16-/18-/24-bit interface) Timing Characteristics

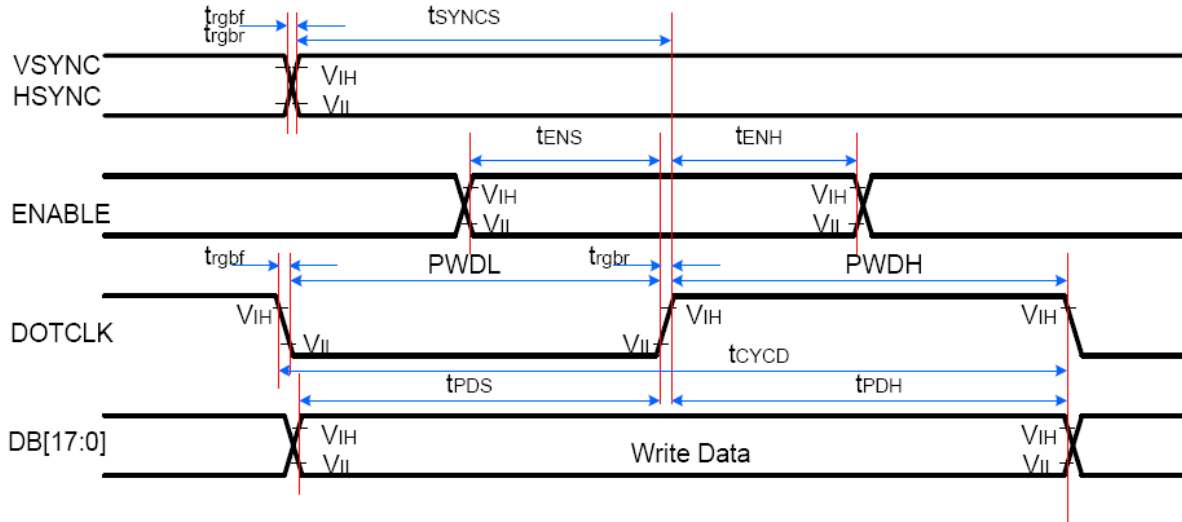

Signal	Symbol	Parameter	min	max	Unit	Description
VSYNC/ HSYNC	t_{SYNCS}	VSYNC/HSYNC setup time	15	-	ns	16-/18-/24-bit bus RGB interface mode
	t_{SYNCH}	VSYNC/HSYNC hold time	15	-	ns	
ENABLE	t_{ENS}	ENABLE setup time	15	-	ns	
	t_{ENH}	ENABLE hold time	15	-	ns	
DB [23:0]	t_{POS}	Data setup time	15	-	ns	
	t_{PDH}	Data hold time	15	-	ns	
DOTCLK	$PWDH$	DOTCLK high-level period	20	-	ns	
	$PWDL$	DOTCLK low-level period	20	-	ns	
	t_{CYCD}	DOTCLK cycle time	50	-	ns	
	t_{rgbr}, t_{rgbf}	DOTCLK,HSYNC,VSYNC rise/fall time	-	15	ns	

Note: $T_a = -30$ to 70 °C, $IOVCC = 1.65V$ to $3.3V$, $VCI = 2.5V$ to $3.3V$, $AGND = DGND = 0V$

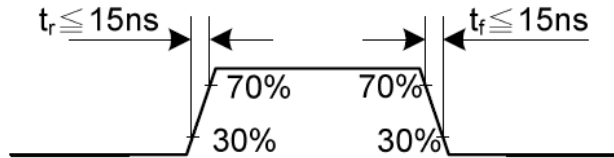

Product Specification



Model: GDT-3.5M320480NB-02

Rev. No.

Issued Date.

Page.

A

2016,04,27

13 / 19

8 Reliability Condition for LCD

No change on display and in operation under the following test condition.

Condition: Unless otherwise specified, tests will be conducted under the following condition.

Temperature: 20±5°C

Humidity: 65±5%RH

Tests will be not conducted under functioning state.

No.	Parameter	Condition	Notes
1	High Temperature Operating	70°C±2°C, 240hrs (Operation state)	--
2	Low Temperature Operating	-20°C±2°C, 240hrs (Operation state)	--
3	High Temperature Storage	80°C±2°C, 240hrs	--
4	Low Temperature Storage	-30°C±2°C, 240hrs	--
5	High Temperature and High Humidity Operation Test	60°C±2°C, 90%, 240hrs	--
6	Vibration Test	Total fixed amplitude: 1.5mm Vibration Frequency: 10~55Hz One cycle 60 seconds to 3 direction of X, Y, Z each 15 minutes.	--

7.	Drop Test	<p>To be measured after dropping from 60cm high on the concrete surface in packing state.</p> <p style="text-align: right;"> <i>Dropping method corner dropping</i> <i>A corner: once</i> <i>Edge dropping</i> <i>B, C, D edge: once</i> <i>Face dropping</i> <i>E, F, G face: once</i> </p>	--
----	-----------	---	----

- Notes:
1. No dew condensation to be observed.
 2. The function test shall be conducted after 4 hours storage at the normal temperature and humidity after removed from the test chamber.
 3. Vibration test will be conducted to the product itself without putting I in a container.

Product Specification



Model: GDT-3.5M320480NB-02

Rev. No.

Issued Date.

Page.

A

2016,04,27

14 / 19

9 Dimensional outlines

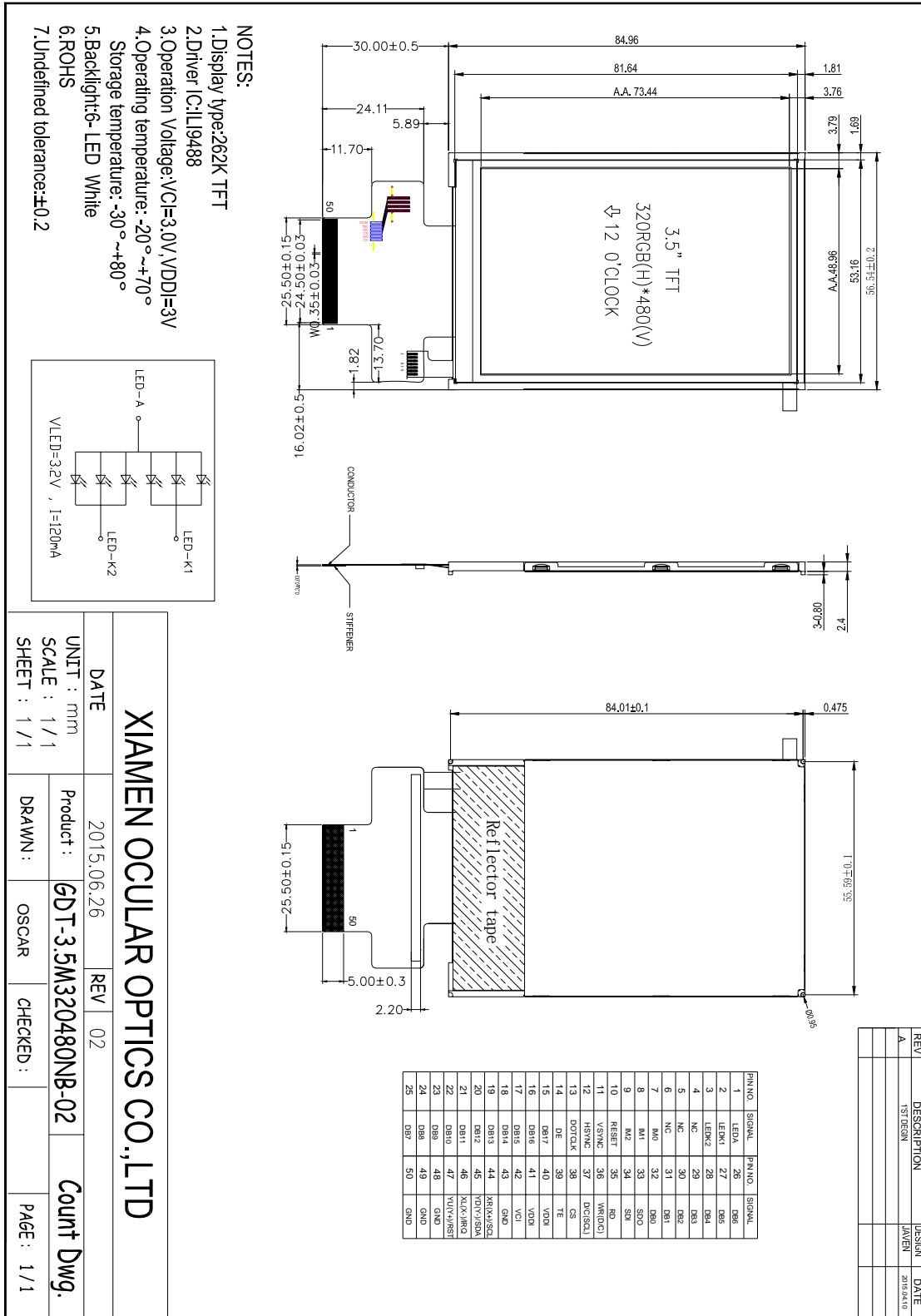

Product Specification

 XIAMEN OCULAR	Model: GDT-3.5M320480NB-02	Rev. No.	Issued Date.	Page.
		A	2016,04,27	15 / 19

10 Incoming Inspection Standards

11.1 VISUAL & FUNCTION INSPECTION STANDARD

11.1.1 Inspection conditions

Inspection performed under the following conditions is recommended.

Temperature : 25±5°C

Humidity : 65%±10%RH

Viewing Angle : Normal viewing Angle.

Illumination: Single fluorescent lamp (300 to 700Lux)

Viewing distance:30-50cm

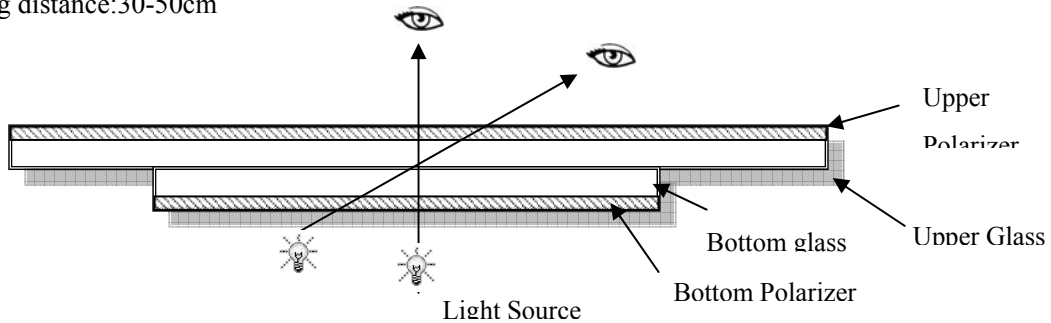

11.1.2 Definition

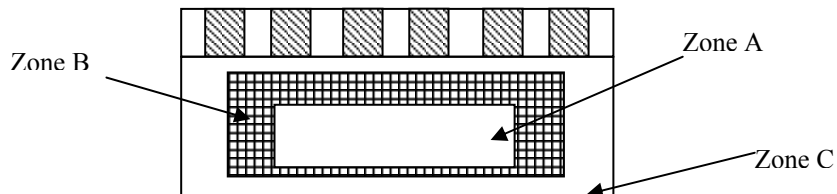

Zone A : Effective Viewing Area(Character or Digit can be seen)

Zone B : Viewing Area except Zone A

Zone C : Outside (Zone A+Zone B) which can not be seen after assembly by customer .)

Note:

As a general rule ,visual defects in Zone C can be ignored when it doesn't effect product function or appearance after assembly by customer.

11.1.3 Sampling Plan

According to GB/T 2828-2003 ; , normal inspection, Class II

AQL:

Major defect	Minor defect
0.65	1.5

Product Specification

	Model: GDT-3.5M320480NB-02	Rev. No.	Issued Date.	Page.
		A	2016,04,27	16 / 19

LCD: Liquid Crystal Display , TP: Touch Panel , LCM: Liquid Crystal Module

No	Items to be inspected	Criteria	Classification of defects
1	Functional defects	1) No display, Open or miss line 2) Display abnormally, Short 3) Backlight no lighting, abnormal lighting. 4) TP no function	Major
2	Missing	Missing component	Major
3	Outline dimension	Overall outline dimension beyond the drawing is not allowed	
4	Color tone	Color unevenness, refer to limited sample	
5	Soldering appearance	Good soldering , Peeling off is not allowed.	Minor
6	LCD/Polarizer/TP	Black/White spot/line, scratch, crack, etc.	

11.1.4 Criteria (Visual)

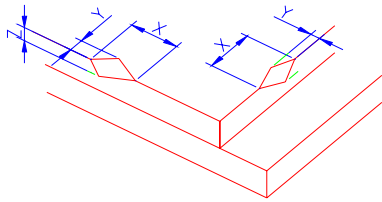
Number	Items	Criteria(mm)						
1.0 LCD Crack/Broken NOTE: X: Length Y: Width	(1) The edge of LCD broken	 <table border="1" style="margin: 10px auto; border-collapse: collapse;"> <thead> <tr> <th style="text-align: center;">X</th> <th style="text-align: center;">Y</th> <th style="text-align: center;">Z</th> </tr> </thead> <tbody> <tr> <td style="text-align: center;">$\leq 3.0\text{mm}$</td> <td style="text-align: center;"><Inner border line of the seal</td> <td style="text-align: center;">$\leq T$</td> </tr> </tbody> </table>	X	Y	Z	$\leq 3.0\text{mm}$	<Inner border line of the seal	$\leq T$
X	Y	Z						
$\leq 3.0\text{mm}$	<Inner border line of the seal	$\leq T$						

Product Specification



Model: GDT-3.5M320480NB-02

Rev. No.

Issued Date.

Page.

A

2016,04,27

17 / 19

Z: Height
L: Length of ITO,
T: Height of LCD

(2)LCD corner broken

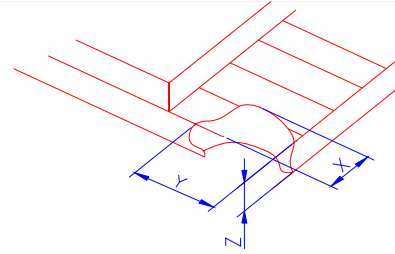

X	Y	Z
≤3.0mm	≤L	≤T

(3) LCD crack

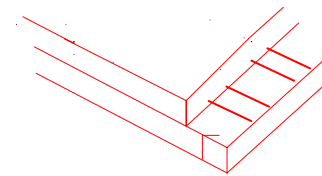

Crack
Not allowed

Product Specification



Model: GDT-3.5M320480NB-02

Rev. No.

Issued Date.

Page.

A

2016,04,27

18 / 19

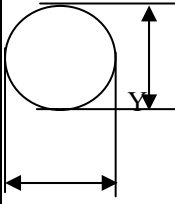
Number	Items	Criteria (mm)																																																																	
2.0	<p>Spot defect</p>  <p style="text-align: center;">$\Phi = (X+Y)/2$</p>	<p>① light dot (LCD/TP/Polarizer black/white spot, light dot, pinhole, dent, stain)</p> <table border="1" style="width: 100%; border-collapse: collapse;"> <thead> <tr> <th rowspan="2" style="text-align: center;">Zone Size (mm)</th> <th colspan="3" style="text-align: center;">Acceptable Qty</th> </tr> <tr> <th style="text-align: center;">A</th> <th style="text-align: center;">B</th> <th style="text-align: center;">C</th> </tr> </thead> <tbody> <tr> <td style="text-align: center;">$\Phi \leq 0.10$</td> <td colspan="3" style="text-align: center;">Ignore</td> </tr> <tr> <td style="text-align: center;">$0.10 < \Phi \leq 0.15$</td> <td colspan="3" style="text-align: center;">3(distance $\geq 10\text{mm}$)</td> </tr> <tr> <td style="text-align: center;">$0.15 < \Phi \leq 0.2$</td> <td colspan="3" style="text-align: center;">1</td> </tr> <tr> <td style="text-align: center;">$0.2 < \Phi$</td> <td colspan="3" style="text-align: center;">0</td> </tr> </tbody> </table> <p>② Dim spot (LCD/TP/Polarizer dim dot, light leakage, dark spot)</p> <table border="1" style="width: 100%; border-collapse: collapse;"> <thead> <tr> <th rowspan="2" style="text-align: center;">Zone Size (mm)</th> <th colspan="3" style="text-align: center;">Acceptable Qty</th> </tr> <tr> <th style="text-align: center;">A</th> <th style="text-align: center;">B</th> <th style="text-align: center;">C</th> </tr> </thead> <tbody> <tr> <td style="text-align: center;">$\Phi \leq 0.1$</td> <td colspan="3" style="text-align: center;">Ignore</td> </tr> <tr> <td style="text-align: center;">$0.1 < \Phi \leq 0.2$</td> <td colspan="3" style="text-align: center;">2(distance $\geq 10\text{mm}$)</td> </tr> <tr> <td style="text-align: center;">$0.2 < \Phi \leq 0.3$</td> <td colspan="3" style="text-align: center;">1</td> </tr> <tr> <td style="text-align: center;">$\Phi > 0.3$</td> <td colspan="3" style="text-align: center;">0</td> </tr> </tbody> </table> <p>③ Polarizer accidented spot</p> <table border="1" style="width: 100%; border-collapse: collapse;"> <thead> <tr> <th rowspan="2" style="text-align: center;">Zone Size (mm)</th> <th colspan="3" style="text-align: center;">Acceptable Qty</th> </tr> <tr> <th style="text-align: center;">A</th> <th style="text-align: center;">B</th> <th style="text-align: center;">C</th> </tr> </thead> <tbody> <tr> <td style="text-align: center;">$\Phi \leq 0.2$</td> <td colspan="3" style="text-align: center;">Ignore</td> </tr> <tr> <td style="text-align: center;">$0.2 < \Phi \leq 0.5$</td> <td colspan="3" style="text-align: center;">2(distance $\geq 10\text{mm}$)</td> </tr> <tr> <td style="text-align: center;">$\Phi > 0.5$</td> <td colspan="3" style="text-align: center;">0</td> </tr> </tbody> </table>	Zone Size (mm)	Acceptable Qty			A	B	C	$\Phi \leq 0.10$	Ignore			$0.10 < \Phi \leq 0.15$	3(distance $\geq 10\text{mm}$)			$0.15 < \Phi \leq 0.2$	1			$0.2 < \Phi$	0			Zone Size (mm)	Acceptable Qty			A	B	C	$\Phi \leq 0.1$	Ignore			$0.1 < \Phi \leq 0.2$	2(distance $\geq 10\text{mm}$)			$0.2 < \Phi \leq 0.3$	1			$\Phi > 0.3$	0			Zone Size (mm)	Acceptable Qty			A	B	C	$\Phi \leq 0.2$	Ignore			$0.2 < \Phi \leq 0.5$	2(distance $\geq 10\text{mm}$)			$\Phi > 0.5$	0		
Zone Size (mm)	Acceptable Qty																																																																		
	A	B	C																																																																
$\Phi \leq 0.10$	Ignore																																																																		
$0.10 < \Phi \leq 0.15$	3(distance $\geq 10\text{mm}$)																																																																		
$0.15 < \Phi \leq 0.2$	1																																																																		
$0.2 < \Phi$	0																																																																		
Zone Size (mm)	Acceptable Qty																																																																		
	A	B	C																																																																
$\Phi \leq 0.1$	Ignore																																																																		
$0.1 < \Phi \leq 0.2$	2(distance $\geq 10\text{mm}$)																																																																		
$0.2 < \Phi \leq 0.3$	1																																																																		
$\Phi > 0.3$	0																																																																		
Zone Size (mm)	Acceptable Qty																																																																		
	A	B	C																																																																
$\Phi \leq 0.2$	Ignore																																																																		
$0.2 < \Phi \leq 0.5$	2(distance $\geq 10\text{mm}$)																																																																		
$\Phi > 0.5$	0																																																																		

Product Specification



Model: GDT-3.5M320480NB-02

Rev. No.

Issued Date.

Page.

A

2016,04,27

19 / 19

	Line defect (LCD/TP /Polarizer black/white line, scratch, stain)	<table border="1" style="width: 100%; text-align: center;"> <thead> <tr> <th rowspan="2">Width(mm)</th> <th rowspan="2">Length(mm)</th> <th colspan="3">Acceptable Qty</th> </tr> <tr> <th>A</th> <th>B</th> <th>C</th> </tr> </thead> <tbody> <tr> <td>$\Phi \leq 0.03$</td> <td>Ignore</td> <td colspan="3">Ignore</td> </tr> <tr> <td>$0.03 < W \leq 0.05$</td> <td>$L \leq 3.0$</td> <td colspan="3">$N \leq 2$</td> </tr> <tr> <td>$0.05 < W \leq 0.08$</td> <td>$L \leq 2.0$</td> <td colspan="3">$N \leq 2$</td> </tr> <tr> <td>$0.08 < W$</td> <td colspan="4">Define as spot defect</td> </tr> </tbody> </table>	Width(mm)	Length(mm)	Acceptable Qty			A	B	C	$\Phi \leq 0.03$	Ignore	Ignore			$0.03 < W \leq 0.05$	$L \leq 3.0$	$N \leq 2$			$0.05 < W \leq 0.08$	$L \leq 2.0$	$N \leq 2$			$0.08 < W$	Define as spot defect			
Width(mm)	Length(mm)	Acceptable Qty																												
		A	B	C																										
$\Phi \leq 0.03$	Ignore	Ignore																												
$0.03 < W \leq 0.05$	$L \leq 3.0$	$N \leq 2$																												
$0.05 < W \leq 0.08$	$L \leq 2.0$	$N \leq 2$																												
$0.08 < W$	Define as spot defect																													
3.0	Polarizer Bubble	<table border="1" style="width: 100%; text-align: center;"> <thead> <tr> <th rowspan="2">Zone Size (mm)</th> <th colspan="3">Acceptable Qty</th> </tr> <tr> <th>A</th> <th>B</th> <th>C</th> </tr> </thead> <tbody> <tr> <td>$\Phi \leq 0.2$</td> <td colspan="3">Ignore</td> </tr> <tr> <td>$0.2 < \Phi < 0.4$</td> <td colspan="3">2(distance ≥ 10mm)</td> </tr> <tr> <td>$0.4 < \Phi < 0.6$</td> <td colspan="3">1</td> </tr> <tr> <td>$0.6 < \Phi$</td> <td colspan="3">0</td> </tr> </tbody> </table>	Zone Size (mm)	Acceptable Qty			A	B	C	$\Phi \leq 0.2$	Ignore			$0.2 < \Phi < 0.4$	2(distance ≥ 10 mm)			$0.4 < \Phi < 0.6$	1			$0.6 < \Phi$	0							
Zone Size (mm)	Acceptable Qty																													
	A	B	C																											
$\Phi \leq 0.2$	Ignore																													
$0.2 < \Phi < 0.4$	2(distance ≥ 10 mm)																													
$0.4 < \Phi < 0.6$	1																													
$0.6 < \Phi$	0																													
4.0	SMT	According to IPC-A-610C class II standard . Function defect and missing part are major defect ,the others are minor defect.																												