

## Product Specification



Model: GDT-3.5M320240LC-01-T

Rev. No.

Issued Date.

Page.

D

2015,04,03

1 / 20

Thin-Film-Transistor LCD Module  
Model: GDT-3.5M320240LC-01-T

Acceptance

Approved and Checked by

Approved by

Checked by

Made by

**XIAMEN OCULAR OPTICS CO., LTD**

## Product Specification



Model: GDT-3.5M320240LC-01-T

Rev. No.	Issued Date.	Page.
D	2015,04,03	2 / 20

### Revise Records

Rev.	Date	Contents	Written	Approved
A	2010/02/03	Preliminary Specification	Kavin Chang	James Lu

### Special Notes

Note1.	
Note2.	
Note3.	
Note4.	
Note5.	

## Product Specification

 <b>XIAMEN OCULAR</b>	Model: GDT-3.5M320240LC-01-T	Rev. No.	Issued Date.	Page.
		D	2015,04,03	3 / 20

### 1. General Description and Features

GDT-3.5M320240LC-01-T is a TM (Transmissive) type color active matrix TFT (Thin Film Transistor) liquid crystal display (LCD) that uses amorphous silicon TFT as a switching device. This model is composed of a TFT-LCD module, a driver circuit and a back-light unit . The resolution of a 3.5" contains 320RGBx240 dots and can display up to 16.7M colors. The following table described the features of GDT-3.5M320240LC-01-T.

#### 1.1 Features

- QVGA(320 x 240 pixels) resolution.
- Display in 16.7M colors.
- On-chip voltage generator.
- SYNC mode is supported for digital RGB input data format.

#### 1.2 LCD Module

Item	Specification	Unit
Screen Size	3.5 inches	Diagonal
Display Resolution	320 x RGB x 240	Dot
Dot Pitch	0.073 (H) x 0.219 (V)	mm
Active Area	70.08 (H) x 52.56 (V)	mm
Outline Dimension	76.9 (W) x 63.9 (H) x 3.27 (D)	mm
Display Mode	Normally white/Transmissive	--
Pixel Arrangement	RGB-Stripe	--
Surface Treatment	Anti-glare (AG)	--
Display Color	16.7M	--
Viewing Direction	6 o'clock (Gray Inversion)	--
Input Interface	Digital 8-bits color RGB	--
Color Gamut	NTSC 60%	--
Drive IC	HX8238	--

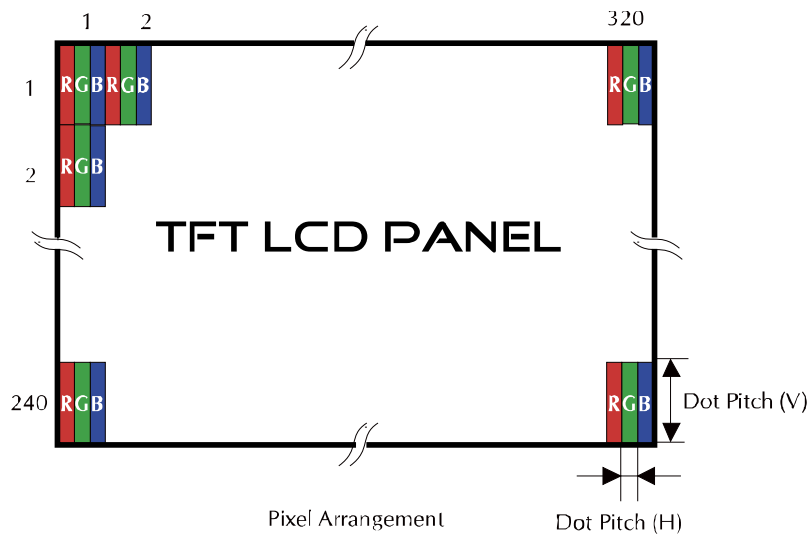

### 2. Mechanical Information

## Product Specification

 <b>XIAMEN OCULAR</b>	Model: GDT-3.5M320240LC-01-T	Rev. No.	Issued Date.	Page.
		D	2015,04,03	4 / 20

Item		Min.	Typ.	Max.	Unit	Note
Module Size	Horizontal (H)	--	76.90	--	mm	--
	Vertical (V)	--	63.90	--	mm	(1)
	Thickness (T)	--	4.7	--	mm	(2)
Weight		--	N/A	--	g	--

Note (1) Not include FPC.

Refer to the Outline Dimension for further information.

(2) Back-light unit are included.

### 3. Electrical Specifications

#### 3.1 Absolute Max. Ratings

##### 3.1.1 Absolute Ratings of Environment

If the operating condition exceeds the following absolute maximum ratings, the TFT LCD module may be damaged permanently.

(Ta=25±2°C, V<sub>SS</sub>=GND=0)

Item	Symbol	Min.	Max.	Unit	Note
Storage temperature	T <sub>STG</sub>	-30	80	°C	(1)
Operating temperature	T <sub>OPR</sub>	-20	70	°C	(1,2,3)

Note (1) 95 % RH Max. ( 40 °C ≥ Ta ). Maximum wet-bulb temperature at 39 °C or less. (Ta > 40 °C)  
No condensation.

Note (2) In case of below 0°, the response time of liquid crystal (LC) becomes slower and the color of panel becomes darker than normal one. Level of retardation depends on temperature, because of LC's character

Note (3) Only operation is guaranteed at operating temperature. Contrast, response time, another display quality are evaluated at +25°C.

#### 3.2 Electrical Absolute Rating

##### 3.2.1 TFT-LCD Module

(Voltage Referenced to VSS)

Item	Symbol	Value		Unit	Condition
		Min.	Max.		
Digital Power Supply Voltage	VDD	VSS-0.3	5.0	V	--

## Product Specification

 <b>XIAMEN OCULAR</b>	Model: GDT-3.5M320240LC-01-T	Rev. No.	Issued Date.	Page.
		D	2015,04,03	5 / 20

### 3.2.2 Back-Light Unit

(Ta=25±2°C)

Item	Symbol	Min.	Max.	Unit	Note
Forward current	$I_f$	--	30	mA	(1)
Reverse voltage	$V_R$	--	5	V	(1)

Note (1) Permanent damage to the device may occur if maximum values are exceeded or reverse voltage is loaded. Functional operation should be restricted to the conditions described under normal operating conditions.

## 4 Electrical Characteristics

### 4.1 TFT-LCD Module (DC Characteristics)

Item	Symbol	Value			Unit	Note
		Min.	Typ.	Max.		
Digital Power Supply Voltage	$V_{DD}$	3.0	3.3	3.6	V	
Input High Threshold Voltage	$V_{IH}$	0.7 VDD	-	VDD	V	
Input Low Threshold Voltage	$V_{IL}$	0	-	0.3 VDD	V	
Power Supply Current	$I_{CC}$	-	(20)	(25)	mA	(1)
Power Consumption	$P_L$	-	(66)	(90)	mW	(1)

Note (1) The specified power consumption is under the conditions at VDD=3.3V ,  $F_V=60\text{Hz}$ , whereas a Power dissipation check pattern below is displayed.

Black Pattern / 0 Gray

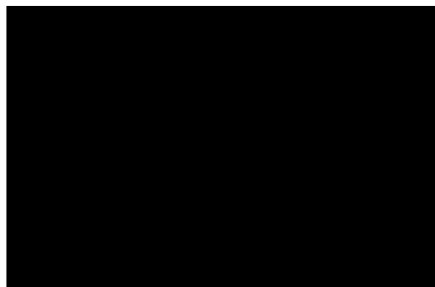

Active Area

### 4.2 Backlight Unit

The back-light system is an edge-lighting type with six white LEDs (Light Emitting Diode).

## Product Specification



Model: GDT-3.5M320240LC-01-T

Rev. No.

Issued Date.

Page.

D

2015,04,03

6 / 20

(Ta=25±2°C)

Item	Symbol	Value			Unit	Condition
		Min.	Typ.	Max.		
LED Voltage	V <sub>F</sub>	18	19.2	20.4	V	
LED Current	I <sub>F</sub>	-	20	25	mA	
Power Consumption	P <sub>BL</sub>	-	384	-	mW	

Note (1) Where I<sub>F</sub> = 20mA, V<sub>F</sub> = 19.2, P<sub>BL</sub> = V<sub>F</sub> × I<sub>F</sub>

### 5 Block Diagram

TFT-LCD Module with Backlight Unit

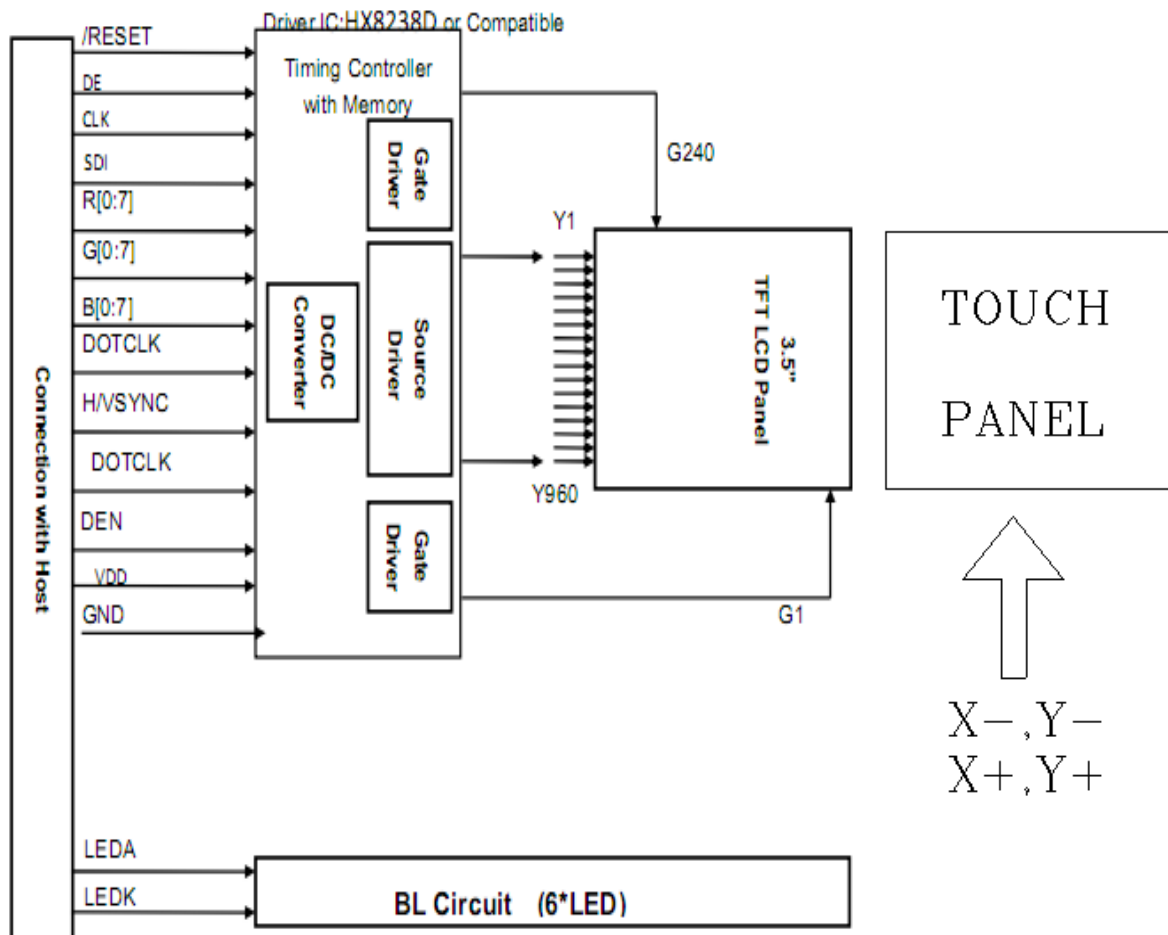

## Product Specification

 <b>XIAMEN OCULAR</b>	Model: GDT-3.5M320240LC-01-T	Rev. No.	Issued Date.	Page.
		D	2015,04,03	7 / 20

### 6 Input Terminal Pin Assignment

#### 6.1 Pin Assignment (LCD)

Pin No.	Symbol	Description
1	LEDK	Backlight LED Ground
2	LEDK	Backlight LED Ground
3	LEDA	Backlight LED Power
4	LEDA	Backlight LED Power
5	NC	Not Use
6	NC	Not Use
7	NC	Not Use
8	/RESET	Hardware Reset
9	SPENA	Serial Interface Data Enable Signal
10	SPCLK	Serial Interface Data Clock
11	SPDAT	Serial interface data input
12	B0	Blue Data Bit0
13	B1	Blue Data Bit1
14	B2	Blue Data Bit2
15	B3	Blue Data Bit3
16	B4	Blue Data Bit4
17	B5	Blue Data Bit5
18	B6	Blue Data Bit6
19	B7	Blue Data Bit7
20	G0	Green Data Bit0
21	G1	Green Data Bit1
22	G2	Green Data Bit2
23	G3	Green Data Bit3
24	G4	Green Data Bit4
25	G5	Green Data Bit5
26	G6	Green Data Bit6
27	G7	Green Data Bit7
28	R0	Red Data Bit0 /DX0

## Product Specification



Model: GDT-3.5M320240LC-01-T

Rev. No.

Issued Date.

Page.

D

2015,04,03

8 / 20

29	R1	Red Data Bit1 /DX1
30	R2	Red Data Bit2 /DX2
31	R3	Red Data Bit3 /DX3
32	R4	Red Data Bit4 /DX4
33	R5	Red Data Bit5 /DX5
34	R6	Red Data Bit6 /DX6
35	R7	Red Data Bit7 /DX7
36	HSYNC	Horizontal Sync Input
37	VSYNC	Vertical Sync Input
38	DCLK	Dot Data Clock
39	NC	Not Use
40	NC	Not Use
41	VDD	Power supply for logic circuits
42	VDD	Power supply for logic circuits
43	NC	Not Use
44	NC	Not Use
45	NC	Not Use
46	NC	Not Use
47	NC	Not Use
48	IF2	Select input interface mode
49	IF1	Select input interface mode
50	IF0	Select input interface mode
51	NC	Not Use
52	DE	Data Enable Input
53	GND	POWER GROUND
54	GND	POWER GROUND



## Product Specification

 <b>XIAMEN OCULAR</b>	Model: GDT-3.5M320240LC-01-T	Rev. No.	Issued Date.	Page.
		D	2015,04,03	9 / 20

### 7 Optical Characteristics

The following items are measured under stable conditions. The optical characteristics should be measured in a dark room or equivalent state with the methods shown in Note (1).

Measuring equipment: BM-5A, BM-7,

(Ta=25±2°C)

Item		Symbol	Condition	Min	Type	Max	Unit	Note	
Brightness		--	$\theta=0^\circ$ Normal Viewing Angle	--	290	--	cd/m <sup>2</sup>	--	
Response time		T <sub>R</sub>		--	15	20	ms	--	
		T <sub>F</sub>		--	35	50	ms		
Contrast ratio		CR		300	400	--	--	--	
Color Chromaticity (CIE1931)		Red		R <sub>X</sub>	--	0.633	--	--	--
				R <sub>Y</sub>	--	0.329	--		
		Green		G <sub>X</sub>	--	0.297	--	--	
				G <sub>Y</sub>	--	0.577	--		
		Blue		B <sub>X</sub>	--	0.133	--	--	
				B <sub>Y</sub>	--	0.129	--		
		White	W <sub>X</sub>	--	0.294	--	--		
			W <sub>Y</sub>	--	0.314	--			
Viewing Angle (6H)	Hor.	$\theta_R$	CR≥10	50	60	--	Degree	--	
		$\theta_L$		50	60	--			
	Ver.	$\phi_H$		40	50	--			
		$\phi_L$		45	55	--			

a. Test equipment setup

After stabilizing and leaving the panel alone shall be warmed up for the stable operation of LCM, the measurement should be executed. Measurement should be executed in a stable, windless, and dark room. Optical specifications are measured by Topcon BM-7(fast) with a viewing angle of 2° at a distance of 50cm and normal direction.

b. Definition of response time: Tr and Tf

The response time is defined as the following figure and shall be measured by switching the input signal for "black" and "white".

## Product Specification



Model: GDT-3.5M320240LC-01-T

Rev. No.

Issued Date.

Page.

D

2015,04,03

10 / 20

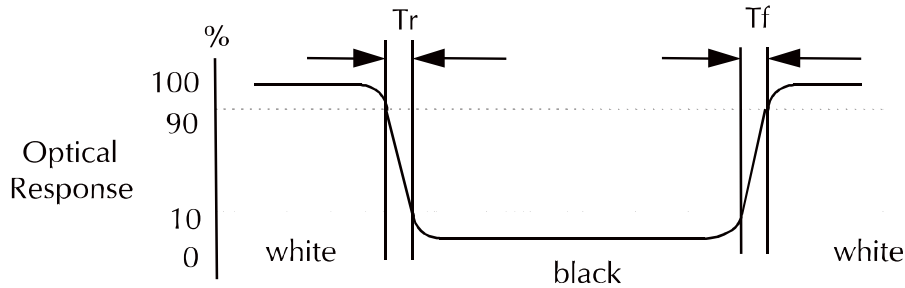

c. Definition of contrast ratio:

Brightness measured when LCD is at "white state"

$$\text{Contrast Ratio (CR)} = \frac{\text{Brightness measured when LCD is at "white state"}}{\text{Brightness measured when LCD is at "black state"}}$$

Brightness measured when LCD is at "black state"

d. Measured at the center area of the panel when all the input terminals of LCD panel are electrically opened.

e. View Angle

**Note 1 : Definition of Viewing Angle  $\theta_x$  and  $\theta_y$  :**

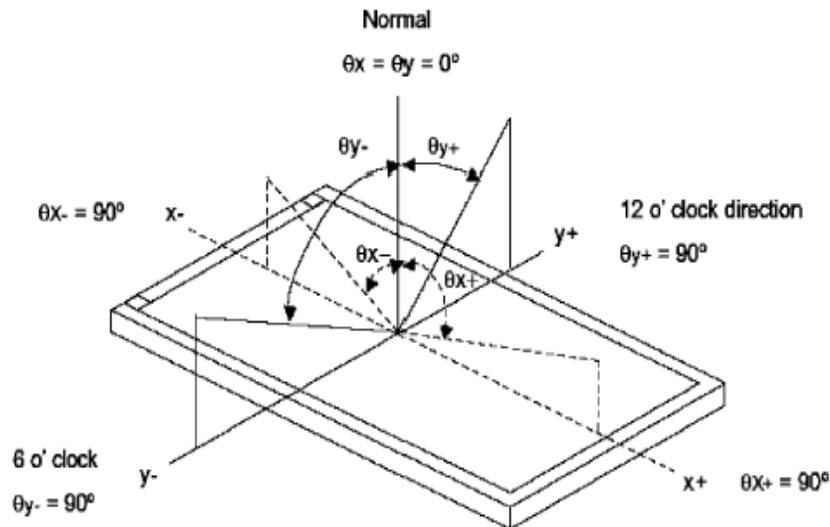

f. Definition of Luminance of White: Luminance of white at the center points

## Product Specification



Model: GDT-3.5M320240LC-01-T

Rev. No.

Issued Date.

Page.

D

2015,04,03

11 / 20

Light Source of Back-Light Unit

LED Type

### g. Definition of White Uniformity

$$\text{White Uniformity} = \frac{\text{Min. luminance of white among 9-points}}{\text{Max. luminance of white among 9-points}}$$

### h. The definition of Color Gamut -Color Chromaticity CIE 1931

Color coordinate of white & red, green, blue at center point.

Color Gamut : NTSC(%) = ( RGB Triangle Area / NTSC Triangle Area ) x 100

## 7-2 Touch panel Characteristics :

1)Construction : film+glass+tail

ITO film:350-450Ω/□ (0.188mm)

ITO glass:500Ω/□ (1.1mm)

tail:FPC (pitch=1.0mm)

Thickness : 1.5max

2)Max voltage : DC3-15V 1mA

3).Insulation resistance : ≥20MΩ(25V DC)

4).Linearity : ≤1.5%

5).Optical characteristics : ≥80%

6).Operation force : <60g

7).Tapping durability : ≥1,000,000次

8).Pen sliding durability : ≥100,000次

9).Hardness:3H

10).Chattering Time:<10ms,

11).Terminal resistance:X:300-800Ω,Y:250-500Ω

## Product Specification



Model: GDT-3.5M320240LC-01-T

Rev. No.

Issued Date.

Page.

D

2015,04,03

12 / 20

### 8 Interface Timing

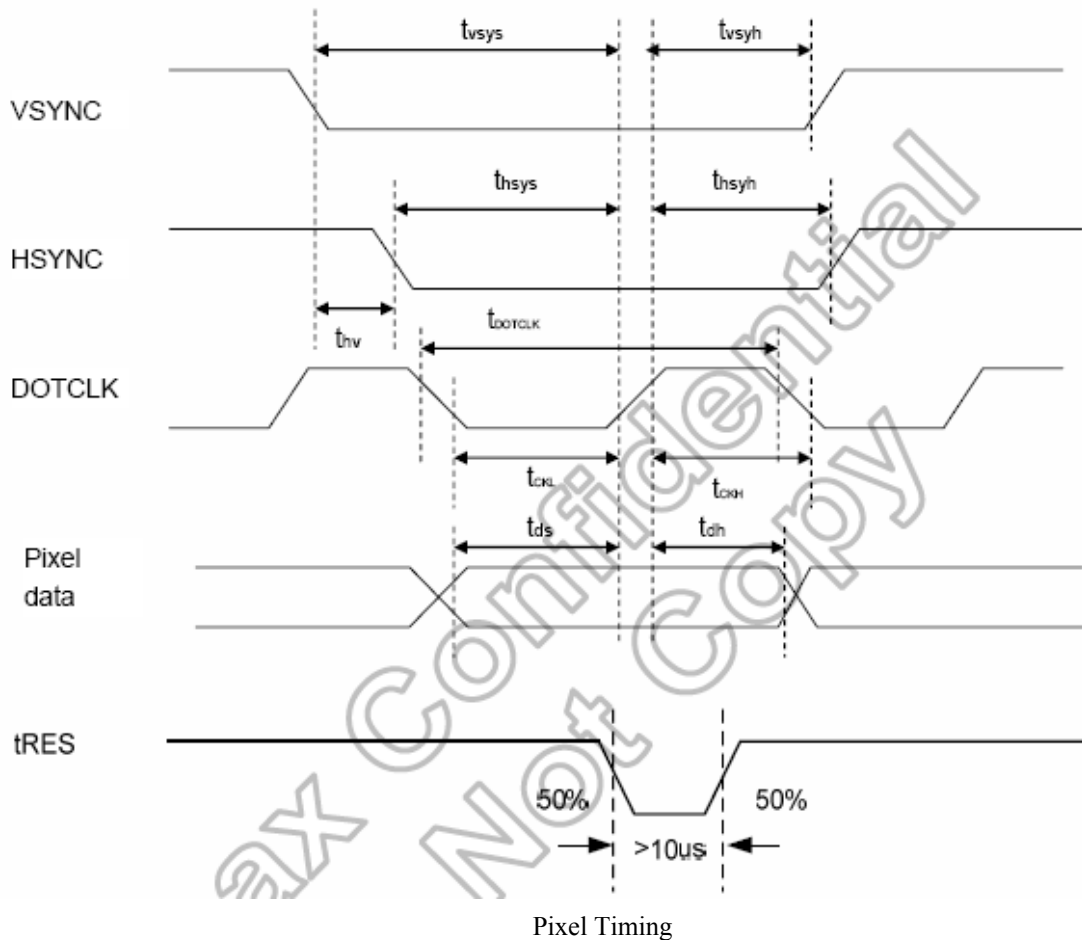

Characteristics	Symbol	Min.		Typ.		Max.		Unit
		24 bit	8 bit	24 bit	8 bit	24 bit	8 bit	
DOTCLK Frequency	fDOTCLK	-	-	6.5	19.5	10	30	MHz
DOTCLK Period	tDOTCLK	100	33.3	154	51.3	-	-	ns
Vertical Sync Setup Time	tvsys	20	10	-	-	-	-	ns
Vertical Sync Hold Time	tvsyh	20	10	-	-	-	-	ns
Horizontal Sync Setup Time	thsys	20	10	-	-	-	-	ns
Horizontal Sync Hold Time	thsyh	20	10	-	-	-	-	ns
Phase difference of Sync Signal Falling Edge	thv	1		-		240		tDOTCLK
DOTCLK Low Period	tCKL	50	15	-	-	-	-	ns
DOTCLK High Period	tCKH	50	15	-	-	-	-	ns
Data Setup Time	tds	12	10	-	-	-	-	ns
Data hold Time	tdh	12	10	-	-	-	-	ns
Reset pulse width	tRES	10		-		-		μs

**Note:** External clock source must be provided to DOTCLK pin of HX8238-D. The driver will not operate if absent of the clocking signal.

## Product Specification



Model: GDT-3.5M320240LC-01-T

Rev. No.

Issued Date.

Page.

D

2015,04,03

13 / 20

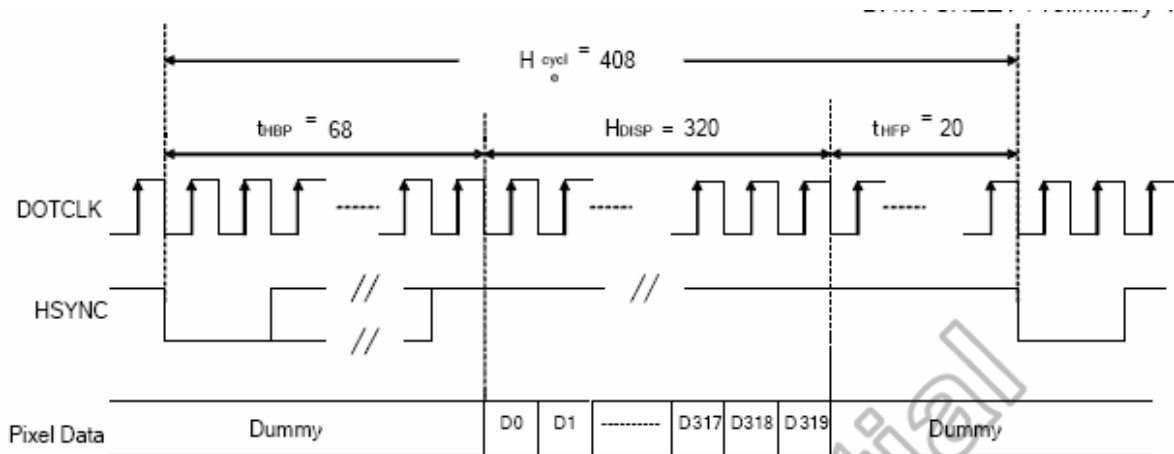

(a) Horizontal Data Transaction Timing

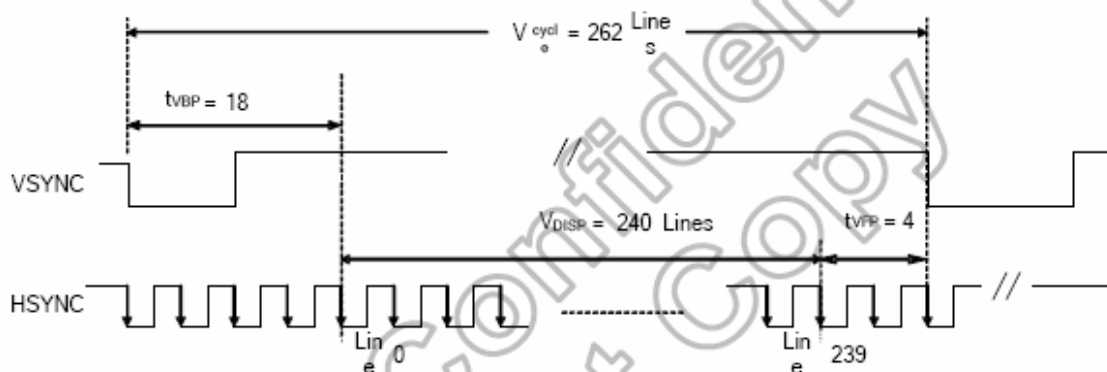

(b) Vertical Data Transaction Timing

Data transaction Timing in parallel RGB(24BIT) interface (SYNC MODE)

Characteristics	Symbol	Min.		Typ.		Max.		Unit
		24 bit	8 bit	24 bit	8 bit	24 bit	8 bit	
DOTCLK Frequency	f <sub>DOTCLK</sub>	-	-	6.5	19.5	10	30	MHz
DOTCLK Period	t <sub>DOTCLK</sub>	100	33.3	154	51.3	-	-	ns
Horizontal Frequency (Line)	f <sub>H</sub>	-	-	14.9		22.35		KHz
Vertical Frequency (Refresh)	f <sub>V</sub>	-	-	60		90		Hz
Horizontal Back Porch	t <sub>HBP</sub>	-	-	68	204	-	-	t <sub>DOTCLK</sub>
Horizontal Front Porch	t <sub>HFP</sub>	-	-	20	60	-	-	t <sub>DOTCLK</sub>
Horizontal Data Start Point	t <sub>HBP</sub>	-	-	68	204	-	-	t <sub>DOTCLK</sub>
Horizontal Blanking Period	t <sub>HBP</sub> + t <sub>HFP</sub>	-	-	88	264	-	-	t <sub>DOTCLK</sub>
Horizontal Display Area	H <sub>DISP</sub>	-	-	320	960	-	-	t <sub>DOTCLK</sub>
Horizontal Cycle	H <sub>cycle</sub>	-	-	408	1224	450	1350	t <sub>DOTCLK</sub>
Vertical Back Porch	t <sub>VBP</sub>	-	-	18		-		Lines
Vertical Front Porch	t <sub>VFP</sub>	-	-	4		-		Lines
Vertical Data Start Point	t <sub>VBP</sub>	-	-	18		-		Lines
Vertical Blanking Period	t <sub>VBP</sub> + t <sub>VFP</sub>	-	-	22		-		Lines
Vertical Display Area	NTSC	-		240		-		Lines
	PAL	-		280(PALM=0)		-		
	PAL	-		288(PALM=1)		-		
Vertical Cycle	NTSC	-		262		350		Lines
	PAL	-		313		-		

## Product Specification

 <b>XIAMEN OCULAR</b>	Model: GDT-3.5M320240LC-01-T	Rev. No.	Issued Date.	Page.
		D	2015,04,03	14 / 20

### 9 Reliability Condition for LCD

No change on display and in operation under the following test condition.

Condition: Unless otherwise specified, tests will be conducted under the following condition.

Temperature: 20±5°C                      Humidity: 65±5%RH

Tests will be not conducted under functioning state.

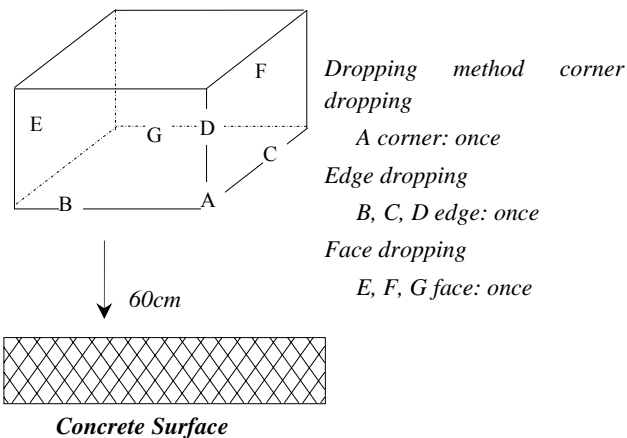
No.	Parameter	Condition	Notes
1	High Temperature Operating	70°C±2°C, 240hrs (Operation state)	--
2	Low Temperature Operating	-20°C±2°C, 240hrs (Operation state)	--
3	High Temperature Storage	80°C±2°C, 240hrs	--
4	Low Temperature Storage	-30°C±2°C, 240hrs	--
5	High Temperature and High Humidity Operation Test	60°C±2°C, 90%, 240hrs	--
6	Vibration Test	Total fixed amplitude: 1.5mm Vibration Frequency: 10~55Hz One cycle 60 seconds to 3 direction of X, Y, Z each 15 minutes.	--
7.	Drop Test	To be measured after dropping from 60cm high on the concrete surface in packing state.   <p style="margin-left: 200px;"> <i>Dropping method corner dropping</i>  <i>A corner: once</i>  <i>Edge dropping</i>  <i>B, C, D edge: once</i>  <i>Face dropping</i>  <i>E, F, G face: once</i> </p>	--

- Notes:
1. No dew condensation to be observed.
  2. The function test shall be conducted after 4 hours storage at the normal temperature and humidity after removed from the test chamber.
  3. Vibration test will be conducted to the product itself without putting I in a container.

# Product Specification



Model: GDT-3.5M320240LC-01-T

Rev. No.

Issued Date.

Page.

D

2015,04,03

15 / 20

## 10 Dimensional outlines

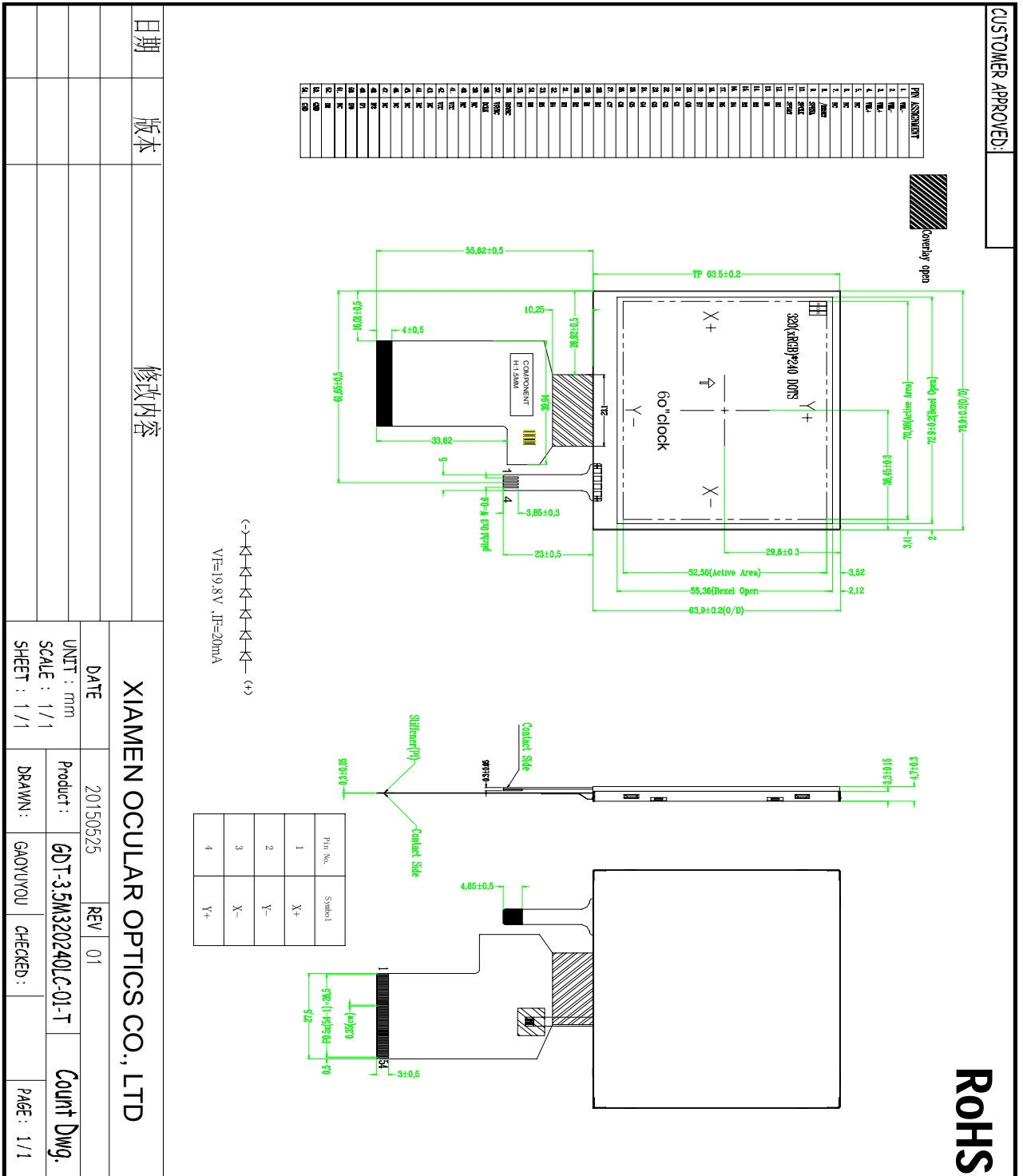

## Product Specification

 <b>XIAMEN OCULAR</b>	Model: GDT-3.5M320240LC-01-T	Rev. No.	Issued Date.	Page.
		D	2015,04,03	16 / 20

### 11 Incoming Inspection Standards

#### 11.1 VISUAL & FUNCTION INSPECTION STANDARD

##### 11.1.1 Inspection conditions

Inspection performed under the following conditions is recommended.

Temperature :  $25 \pm 5^{\circ}\text{C}$

Humidity :  $65\% \pm 10\% \text{RH}$

Viewing Angle : Normal viewing Angle.

Illumination: Single fluorescent lamp (300 to 700Lux)

Viewing distance: 30-50cm

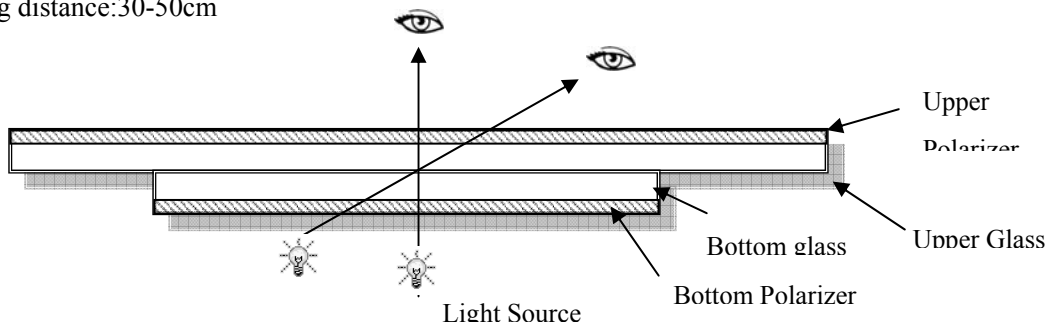

##### 11.1.2 Definition

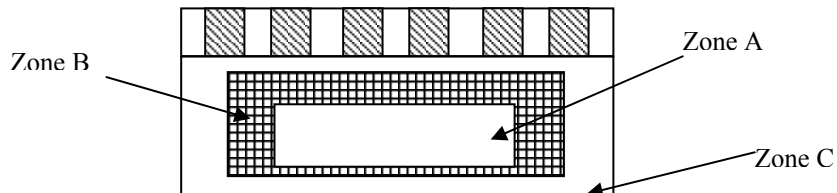

Zone A : Effective Viewing Area(Character or Digit can be seen)

Zone B : Viewing Area except Zone A

Zone C : Outside (Zone A+Zone B) which can not be seen after assembly by customer .)

Note:

As a general rule ,visual defects in Zone C can be ignored when it doesn't effect product function or appearance after assembly by customer.

##### 11.1.3 Sampling Plan

According to GB/T 2828-2003 ; , normal inspection, Class II

Address: 2/F, Building No.899, 2nd Tonglong Road, Torch High Technology Development Area, Xiamen 361106, China  
 Phone: +86-592-5715296/5650516 Fax: +86-592-5650695 Web: [www.xmocular.com](http://www.xmocular.com) E-mail: lee@xmocular.com



## Product Specification

 <b>XIAMEN OCULAR</b>	Model: GDT-3.5M320240LC-01-T	Rev. No.	Issued Date.	Page.
		D	2015,04,03	17 / 20

AQL:

Major defect	Minor defect
0.65	1.5

LCD: Liquid Crystal Display , TP: Touch Panel , LCM: Liquid Crystal Module

No	Items to be inspected	Criteria	Classification of defects
1	Functional defects	1) No display, Open or miss line 2) Display abnormally, Short 3) Backlight no lighting, abnormal lighting. 4) TP no function	Major
2	Missing	Missing component	
3	Outline dimension	Overall outline dimension beyond the drawing is not allowed	
4	Color tone	Color unevenness, refer to limited sample	Minor
5	Soldering appearance	Good soldering , Peeling off is not allowed.	
6	LCD/Polarizer/TP	Black/White spot/line, scratch, crack, etc.	

### 11.1.4 Criteria (Visual)

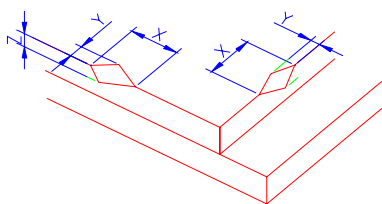
Number	Items	Criteria(mm)						
1.0 LCD Crack/Broken  NOTE: X: Length Y: Width	(1) The edge of LCD broken	 <table border="1" style="margin: 10px auto; border-collapse: collapse; text-align: center;"> <tr> <td style="width: 33%;">X</td> <td style="width: 33%;">Y</td> <td style="width: 33%;">Z</td> </tr> <tr> <td>≤3.0mm</td> <td>&lt;Inner border line of</td> <td>≤T</td> </tr> </table> <p style="text-align: center; margin-top: 5px;">the seal</p>	X	Y	Z	≤3.0mm	<Inner border line of	≤T
X	Y	Z						
≤3.0mm	<Inner border line of	≤T						

## Product Specification



Model: GDT-3.5M320240LC-01-T

Rev. No.

Issued Date.

Page.

D

2015,04,03

18 / 20

Z: Height  
L: Length of ITO,  
T: Height of LCD

(2)LCD corner broken

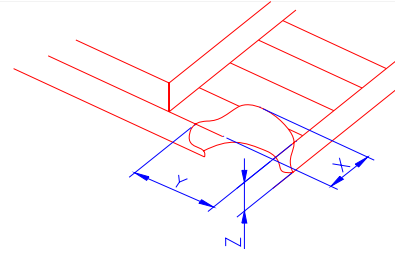

X	Y	Z
≤3.0mm	≤L	≤T

(3) LCD crack

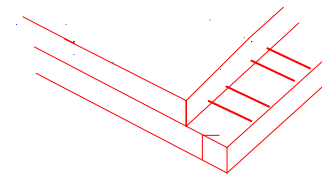

Crack  
Not allowed

## Product Specification



Model: GDT-3.5M320240LC-01-T

Rev. No.

Issued Date.

Page.

D

2015,04,03

19 / 20

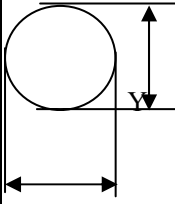
Number	Items	Criteria (mm)																							
2.0	Spot defect  $\Phi = (X+Y)/2$	① light dot (LCD/TP/Polarizer black/white spot, light dot, pinhole, dent, stain) <table border="1" style="width: 100%; border-collapse: collapse;"> <thead> <tr> <th rowspan="2" style="text-align: center;">Zone Size (mm)</th> <th colspan="3" style="text-align: center;">Acceptable Qty</th> </tr> <tr> <th style="text-align: center;">A</th> <th style="text-align: center;">B</th> <th style="text-align: center;">C</th> </tr> </thead> <tbody> <tr> <td style="text-align: center;"><math>\Phi \leq 0.10</math></td> <td colspan="3" style="text-align: center;">Ignore</td> </tr> <tr> <td style="text-align: center;"><math>0.10 &lt; \Phi \leq 0.15</math></td> <td colspan="3" style="text-align: center;">3( distance <math>\geq 10\text{mm}</math>)</td> </tr> <tr> <td style="text-align: center;"><math>0.15 &lt; \Phi \leq 0.2</math></td> <td colspan="3" style="text-align: center;">1</td> </tr> <tr> <td style="text-align: center;"><math>0.2 &lt; \Phi</math></td> <td colspan="3" style="text-align: center;">0</td> </tr> </tbody> </table>	Zone Size (mm)	Acceptable Qty			A	B	C	$\Phi \leq 0.10$	Ignore			$0.10 < \Phi \leq 0.15$	3( distance $\geq 10\text{mm}$ )			$0.15 < \Phi \leq 0.2$	1			$0.2 < \Phi$	0		
Zone Size (mm)	Acceptable Qty																								
	A	B	C																						
$\Phi \leq 0.10$	Ignore																								
$0.10 < \Phi \leq 0.15$	3( distance $\geq 10\text{mm}$ )																								
$0.15 < \Phi \leq 0.2$	1																								
$0.2 < \Phi$	0																								
		② Dim spot (LCD/TP/Polarizer dim dot, light leakage, dark spot) <table border="1" style="width: 100%; border-collapse: collapse;"> <thead> <tr> <th rowspan="2" style="text-align: center;">Zone Size (mm)</th> <th colspan="3" style="text-align: center;">Acceptable Qty</th> </tr> <tr> <th style="text-align: center;">A</th> <th style="text-align: center;">B</th> <th style="text-align: center;">C</th> </tr> </thead> <tbody> <tr> <td style="text-align: center;"><math>\Phi \leq 0.1</math></td> <td colspan="3" style="text-align: center;">Ignore</td> </tr> <tr> <td style="text-align: center;"><math>0.1 &lt; \Phi \leq 0.2</math></td> <td colspan="3" style="text-align: center;">2( distance <math>\geq 10\text{mm}</math>)</td> </tr> <tr> <td style="text-align: center;"><math>0.2 &lt; \Phi \leq 0.3</math></td> <td colspan="3" style="text-align: center;">1</td> </tr> <tr> <td style="text-align: center;"><math>\Phi &gt; 0.3</math></td> <td colspan="3" style="text-align: center;">0</td> </tr> </tbody> </table>	Zone Size (mm)	Acceptable Qty			A	B	C	$\Phi \leq 0.1$	Ignore			$0.1 < \Phi \leq 0.2$	2( distance $\geq 10\text{mm}$ )			$0.2 < \Phi \leq 0.3$	1			$\Phi > 0.3$	0		
Zone Size (mm)	Acceptable Qty																								
	A	B	C																						
$\Phi \leq 0.1$	Ignore																								
$0.1 < \Phi \leq 0.2$	2( distance $\geq 10\text{mm}$ )																								
$0.2 < \Phi \leq 0.3$	1																								
$\Phi > 0.3$	0																								
		③ Polarizer accidented spot <table border="1" style="width: 100%; border-collapse: collapse;"> <thead> <tr> <th rowspan="2" style="text-align: center;">Zone Size (mm)</th> <th colspan="3" style="text-align: center;">Acceptable Qty</th> </tr> <tr> <th style="text-align: center;">A</th> <th style="text-align: center;">B</th> <th style="text-align: center;">C</th> </tr> </thead> <tbody> <tr> <td style="text-align: center;"><math>\Phi \leq 0.2</math></td> <td colspan="3" style="text-align: center;">Ignore</td> </tr> <tr> <td style="text-align: center;"><math>0.2 &lt; \Phi \leq 0.5</math></td> <td colspan="3" style="text-align: center;">2( distance <math>\geq 10\text{mm}</math>)</td> </tr> <tr> <td style="text-align: center;"><math>\Phi &gt; 0.5</math></td> <td colspan="3" style="text-align: center;">0</td> </tr> </tbody> </table>	Zone Size (mm)	Acceptable Qty			A	B	C	$\Phi \leq 0.2$	Ignore			$0.2 < \Phi \leq 0.5$	2( distance $\geq 10\text{mm}$ )			$\Phi > 0.5$	0						
Zone Size (mm)	Acceptable Qty																								
	A	B	C																						
$\Phi \leq 0.2$	Ignore																								
$0.2 < \Phi \leq 0.5$	2( distance $\geq 10\text{mm}$ )																								
$\Phi > 0.5$	0																								

## Product Specification



Model: GDT-3.5M320240LC-01-T

Rev. No.

Issued Date.

Page.

D

2015,04,03

20 / 20

	Line defect (LCD/TP /Polarizer black/white line, scratch, stain)	<table border="1" style="width: 100%; text-align: center;"> <thead> <tr> <th rowspan="2">Width(mm)</th> <th rowspan="2">Length(mm)</th> <th colspan="3">Acceptable Qty</th> </tr> <tr> <th>A</th> <th>B</th> <th>C</th> </tr> </thead> <tbody> <tr> <td><math>\Phi \leq 0.03</math></td> <td>Ignore</td> <td colspan="3">Ignore</td> </tr> <tr> <td><math>0.03 &lt; W \leq 0.05</math></td> <td><math>L \leq 3.0</math></td> <td colspan="3"><math>N \leq 2</math></td> </tr> <tr> <td><math>0.05 &lt; W \leq 0.08</math></td> <td><math>L \leq 2.0</math></td> <td colspan="3"><math>N \leq 2</math></td> </tr> <tr> <td><math>0.08 &lt; W</math></td> <td colspan="4">Define as spot defect</td> </tr> </tbody> </table>	Width(mm)	Length(mm)	Acceptable Qty			A	B	C	$\Phi \leq 0.03$	Ignore	Ignore			$0.03 < W \leq 0.05$	$L \leq 3.0$	$N \leq 2$			$0.05 < W \leq 0.08$	$L \leq 2.0$	$N \leq 2$			$0.08 < W$	Define as spot defect			
Width(mm)	Length(mm)	Acceptable Qty																												
		A	B	C																										
$\Phi \leq 0.03$	Ignore	Ignore																												
$0.03 < W \leq 0.05$	$L \leq 3.0$	$N \leq 2$																												
$0.05 < W \leq 0.08$	$L \leq 2.0$	$N \leq 2$																												
$0.08 < W$	Define as spot defect																													
3.0	Polarizer Bubble	<table border="1" style="width: 100%; text-align: center;"> <thead> <tr> <th rowspan="2">Zone Size (mm)</th> <th colspan="3">Acceptable Qty</th> </tr> <tr> <th>A</th> <th>B</th> <th>C</th> </tr> </thead> <tbody> <tr> <td><math>\Phi \leq 0.2</math></td> <td colspan="3">Ignore</td> </tr> <tr> <td><math>0.2 &lt; \Phi &lt; 0.4</math></td> <td colspan="3">2(distance <math>\geq 10</math>mm)</td> </tr> <tr> <td><math>0.4 &lt; \Phi \leq 0.6</math></td> <td colspan="3">1</td> </tr> <tr> <td><math>0.6 &lt; \Phi</math></td> <td colspan="3">0</td> </tr> </tbody> </table>	Zone Size (mm)	Acceptable Qty			A	B	C	$\Phi \leq 0.2$	Ignore			$0.2 < \Phi < 0.4$	2(distance $\geq 10$ mm)			$0.4 < \Phi \leq 0.6$	1			$0.6 < \Phi$	0							
Zone Size (mm)	Acceptable Qty																													
	A	B	C																											
$\Phi \leq 0.2$	Ignore																													
$0.2 < \Phi < 0.4$	2(distance $\geq 10$ mm)																													
$0.4 < \Phi \leq 0.6$	1																													
$0.6 < \Phi$	0																													
4.0	SMT	According to IPC-A-610C class II standard . Function defect and missing part are major defect ,the others are minor defect.																												